



Your ONLY Transit Safety Solution

I-Mobile Solutions



NDA **TAA**
Compliant Compliant

Next-Generation Vehicle Surveillance System: Unmatched Performance and Integration

From pioneers in mobile systems to leaders in innovation
Experience IDIS' I-Mobile system. The first, the best, the right solution

I-Mobile Solutions

59,000 systems with over
400,000 cameras installed since
2005. Securing vehicles with IDIS in
North America



Total Cost of Ownership



Reliability with Proven
Best Practices



Commitment to
Excellence



IDIS Innovation Timeline

Leading the Way in Mobile Video Surveillance

IDIS has consistently pioneered advancements in mobile video surveillance, driving the industry forward with groundbreaking innovations. We revolutionized surveillance with our network solutions, offering scalable and adaptable systems that meet diverse needs. IDIS remains at the forefront of the industry, continually shaping the future of mobile video surveillance with our cutting-edge solutions.



The Technology Leader



I-Mobile Solutions

NDAA
Compliant

TAA
Compliant

Assembly in United States

High-Performance 4K Mobile Solution Provides Transit and Fleet Operators with an Intuitive User Interface and Seamless System Compatibility

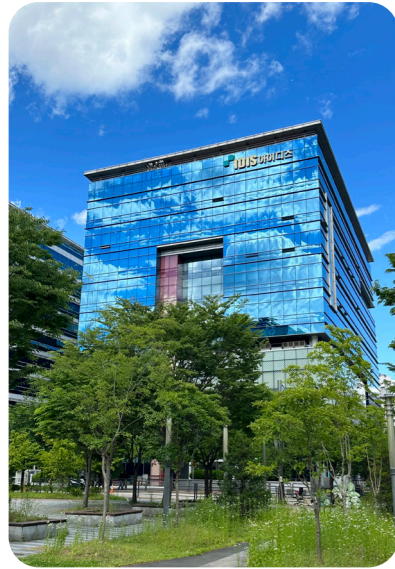

Pioneering Vehicle Surveillance Since 2005

With 20 years of behind-the-scenes innovation in mobile video surveillance, IDIS NOW brings our expertise directly to you

As a pioneer in vehicle surveillance systems, IDIS has been crafting ODM products and technologies since 2005. While our name might not ring bells, the technologies that once dominated the market were largely born from IDIS. We are the original architects behind the advancements that fueled the former top ODM. This brochure serves as an introduction to highlight IDIS' deep-rooted expertise and substantial track record in the vehicle surveillance industry.



- Unrivaled 4K resolution with 16-channel real-time and long-term stream recording



- Structured design for optimal stability in vehicle vibrations, shocks, and power environments



- Integrated GPS and acceleration sensors for tracking locations and detecting collisions and sharp turns



IDIS I-Mobile Solutions



- Seamless integration with vehicle information systems for unified display of video and vehicle data



- Utilizes iBank database for video security, resilient to 90%+ HDD loss, from various events

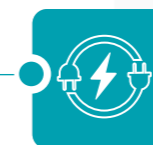

- Cellular unit design minimizes damage from external electrical shocks



Unmatched Clarity, Unyielding Performance

Transform your fleet into a secure fortress with our advanced system, featuring unparalleled 4K resolution and robust 16-channel real-time recording. Designed for superior image quality and enduring performance, it's perfect for critical applications in law enforcement, emergency response, and commercial transportation. Easily integrate into your existing setup for peace of mind with comprehensive coverage and reliable maintenance agreements. The IDIS Solution Suite Expert and IDIS Solution Suite Backup modules ensure continuous backup of event-triggered videos from up to 1,024 devices, making it the ideal solution for any application with its versatile software modules.



Streamlined Installation, Effortlessly Fast and Easy

IDIS transforms system installations with advanced technologies like AutoIP, multicast DNS, and DNS service directory techniques. Engineered for speed and simplicity, our systems enable plug-and-play setups without the complexities of IP networking. This approach speeds up deployments and cuts installation costs by eliminating the need for specialist support, making it cost-efficient to empower your fleet with cutting-edge vehicle system technology.



Reliability in Extreme Conditions

Our system ensures unparalleled reliability in extreme conditions with a structured design that maintains optimal stability. It operates seamlessly amidst vehicle vibrations, shocks, and fluctuating power environments, making it ideal for vehicles in harsh or unpredictable conditions. Count on continuous operation and safety without the risk of data or functional loss.

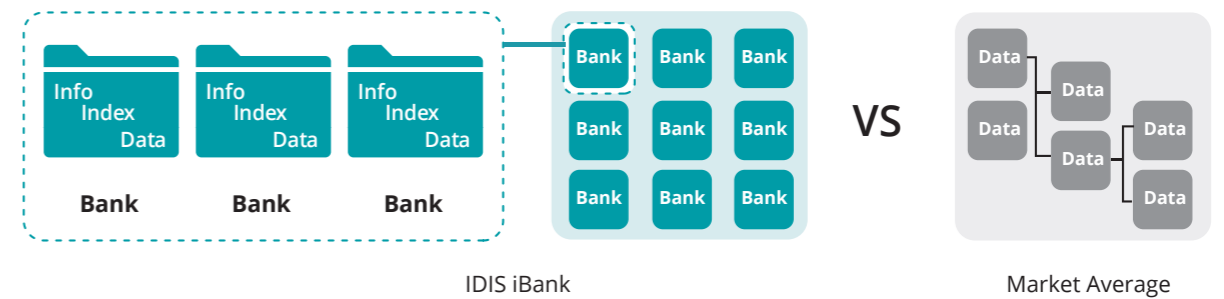

Advanced Data Security with iBank Technology

I-Mobile Solutions is equipped with a specialized iBank database, providing unparalleled video security. It boasts resilience to over 90% of physical hard drive losses and includes a unique self-recovery capability for various data loss events. This ensures critical video data remains protected and recoverable, enhancing reliability and instilling trust in our technology.

Enhanced Protection Against Electrical Interference

Our system features an innovative cellular unit design that effectively minimizes damage from external electrical shocks. This safeguard protects system integrity and extends its lifespan, ensuring consistent performance even in environments with high electrical interference. This makes our system a cost-effective and reliable choice for modern vehicles that demand operational excellence.



Unified NVR Data Consolidation: Seamlessly Integrating Metadata and Video for Dynamic Situation Analysis

IDIS I-Mobile NVRs are crafted from years of innovation, offering a unified power and connectivity solution for mobile security systems. These NVRs provide and manage power for multiple devices from a single source, ensuring reliable performance in diverse external conditions. By minimizing extensive wiring needs and harnessing IDIS's specialized technology, we deliver a robust and user-friendly security solution ideal for any demanding environment.

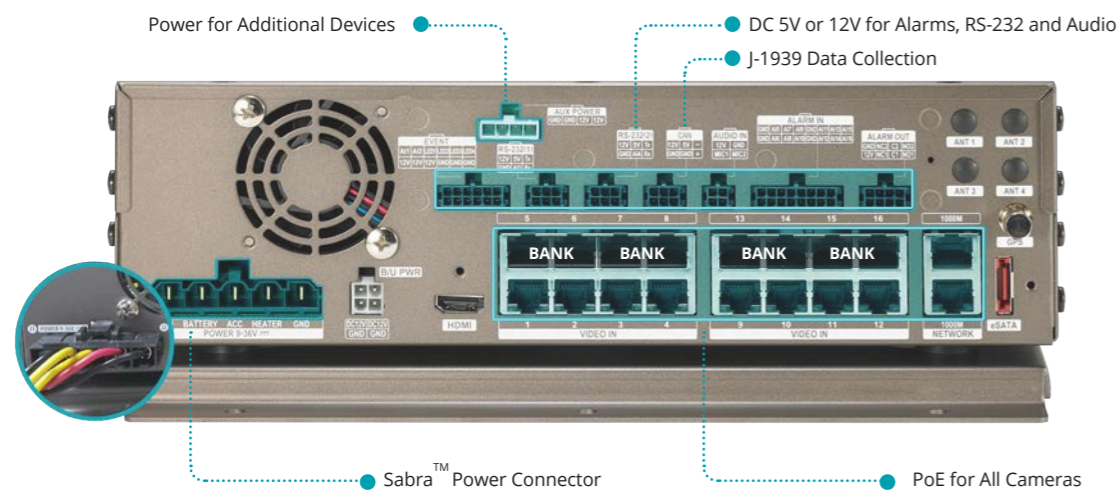

One Communication Source & Control: Simplified NVR Management without Additional Device

Our Unique IDIS I-Mobile NVR system integrates all communication and control needs into one. From video data to accelerometer readings, GPS locations, thermal sensor temperatures, signal inputs (left/right/brake), third-party devices, driver events, and power statuses, manage everything seamlessly without the need for extra modems or devices.

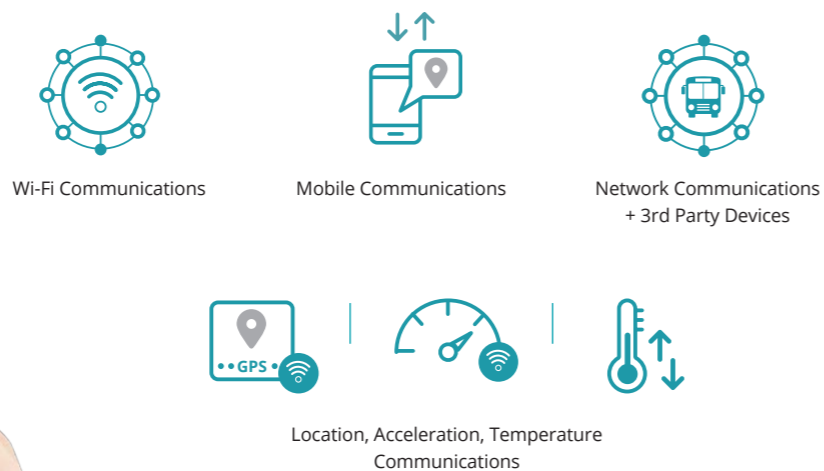

Ensuring System Reliability with Reliable Data Backup and Long-Term Recording, Even in the Face of Vibration and Shock

Seamlessly integrate into a centralized monitoring environment with wireless automatic data backup, while maintaining high-quality video for critical incidents through dual-track recording and accommodating long-term data retention requirements. Experience uninterrupted operation with our Isolated Power Block design, which minimizes power damage and ensures easier maintenance. Plus, ensure data protection with power pack backup in case of power loss due to accidents.

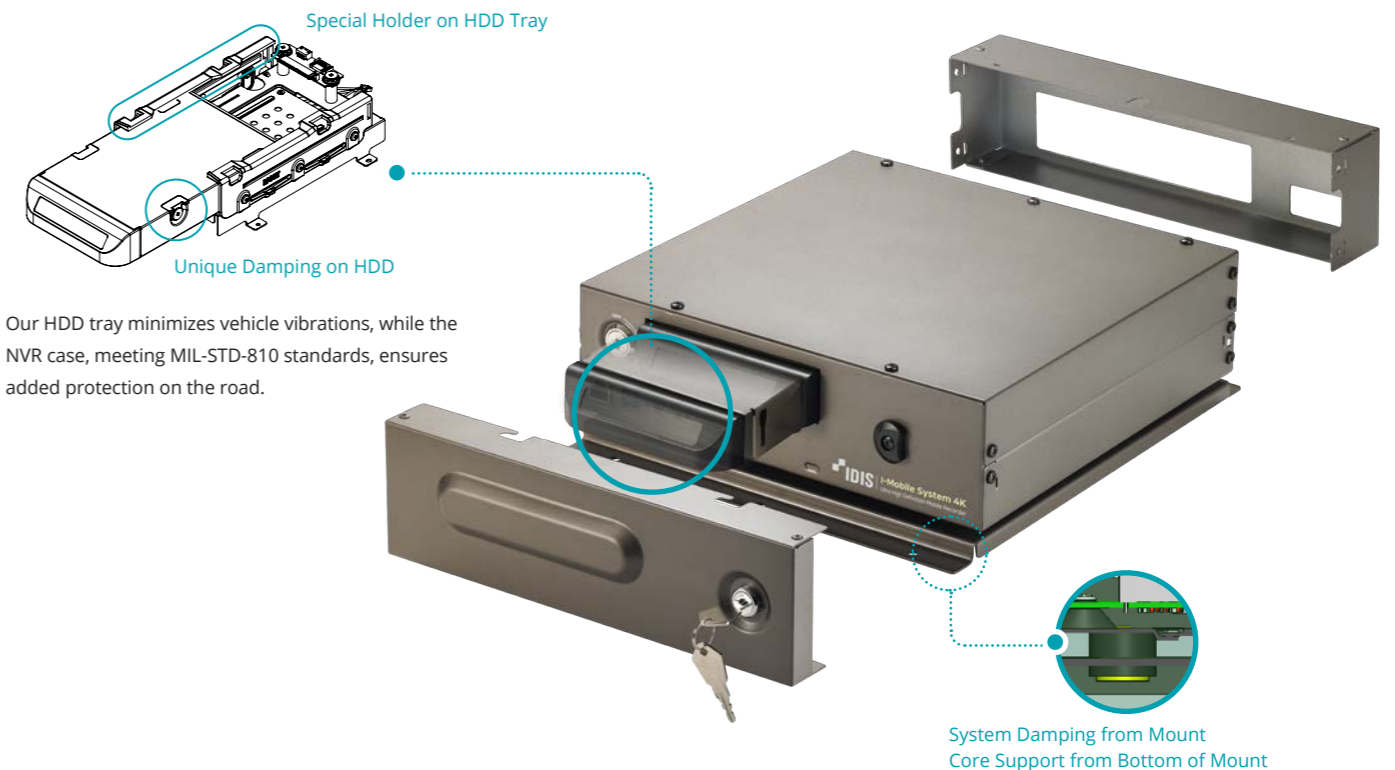

Our HDD tray minimizes vehicle vibrations, while the NVR case, meeting MIL-STD-810 standards, ensures added protection on the road.

Enhance your onboard video system

Manage your operations effortlessly with our comprehensive dashboard, which provides health monitoring insights, Google Maps integration, and live vehicle status updates. Our platform offers seamless navigation through various search, playback, and video extraction features, all designed with an intuitive and user-friendly interface. Best of all, these powerful tools are available free of charge, delivering exceptional value for managing multiple onboard systems.





Empowering fleet management and safety through enhanced control and insight.

Revolutionize Vehicle Safety and Operational Efficiency

Introducing a cutting-edge monitoring solution designed to transform your vehicle fleet's safety and performance. Our comprehensive system integrates advanced GPS and acceleration sensors to provide real-time location tracking and detect critical events, such as collisions and abrupt driving maneuvers.

IDIS Smart Failover

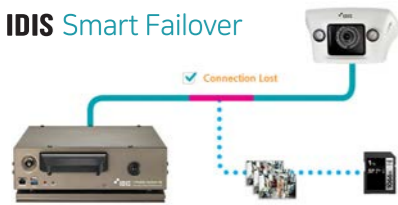

In Case of Network Failure

When the NVR and IP camera are disconnected, the camera's SD card instantly begins recording and automatically transfers the data to the NVR after recovery, leaving no incident unrecorded.



Unified Platform

IDIS integrates video surveillance seamlessly with vehicle data onto a single, intuitive interface. This consolidation simplifies monitoring and enhances decision-making capabilities.



Streamlined Operations

By consolidating multiple data sources onto one screen, IDIS optimizes workflow efficiency. Fleet operators can swiftly analyze critical information, leading to faster response times and proactive management.



Future-Proof and Cost-Effective Technology Solutions

IDIS ensures seamless integration and cost-effective upgrades with our technology solutions. Our commitment to compatibility across legacy systems, modern devices, and existing DVRs provides organizations a smooth transition to advanced technology without immediate overhauls. This approach reduces upfront costs, supports phased upgrades, and extends system lifespan, preparing businesses for future advancements.



Leading the Way in Transit Bus Security – IDIS's Exclusive 5-Year Warranty

IDIS is setting a new industry benchmark with our pioneering five-year warranty for onboard security systems. Choose a security system that guarantees no data loss during critical events, backed by superior technology and trustworthy manufacturers. Our solutions are NDAA-compliant and Made-in-Korea. Provides longer-lasting coverage and support.



NDAA Compliant **TAA** Compliant
Assembly in United States



IDIS SOLUTION SUITE®



Experience comprehensive, customizable, and future-proof remote monitoring solutions with the IDIS Solution Suite Mobile from your mobile device anytime, anywhere

Enjoy seamless access to IDIS Solution Suite Expert registered devices anytime, anywhere, via network connectivity. Experience the IDIS Solution Suite Mobile Archive difference — a robust foundation designed to elevate your surveillance capabilities to new heights. Our modular approach ensures easy scalability to meet your expanding operational demands. Tailor your solution with customization options that cater precisely to your project's unique needs and benefit from one-time license purchases with complimentary upgrades, ensuring your system evolves seamlessly without additional expenses.

- One Time License**
- Free-Upgrade**

Custom Clip
 Customized clips for any given period of date/time from selected vehicles

Auto Clip
 Automatically created clips triggered by events that pre-configured by admin users

Health Notification
 Easy and quick catch on physical issues by notifying Device/Network/Server health status to users via email on a regular basis

Dashboard
 Monitoring of the overall clip-download status at a glance

System Health Monitoring
 Proactive device monitoring for uninterrupted operations

Batch Import and Export
 Simple import or export of registered device lists and configurations

Central Monitoring and Response
 Centralized alarm and event management, acknowledgement, and escalation for enhanced visual awareness and rapid, coordinated responses to incidents

Low Bandwidth Communication
 IDIS recorders and designed to support extremely low bandwidth conditions of less than 24KB



Live View
 Experience live feeds in a multi-grid layout supporting up to 16-channels simultaneously

Search and View
 Effortlessly search and view recordings with 1-channel recording service



Dewarping Control
 Streamlined PTZ (Fisheye Dewarping) IDIS Smart UX Controls interface for easy command



IDIS CENTER

Powerful, Free Software for Up to 1,024 Buses

Unlock the Potential of IDIS Center: A state-of-the-art intelligent mobile video surveillance management offered completely free of charge. Designed to effortlessly handle up to 1,024 devices, it seamlessly scales to support over 16,000 IP cameras. IDIS Center empowers users with robust capabilities, including real-time live monitoring and advanced map-based surveillance features. Beyond its powerful functionality, it provides extensive customization options, ensuring users can tailor every aspect to meet their specific needs as a versatile Video Management System (VMS).

- 

License-Free VMS
- 

Customization

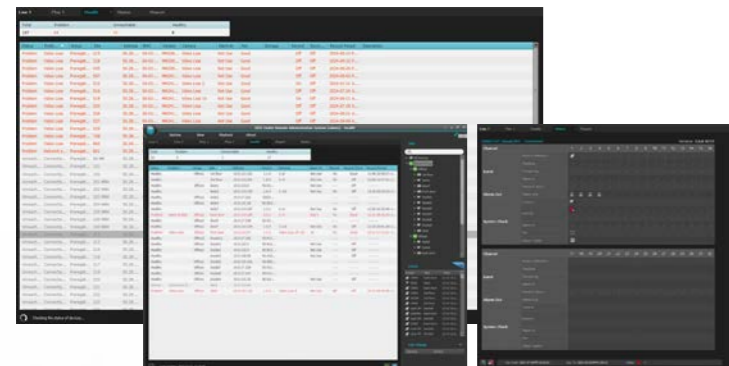

Multiple System Health & Event Monitoring

This window provides a comprehensive overview of the health status of all registered NVRs (up to 1,024 units) in the IDIS Center. You can easily access a summary of NVR information and the status of connected cameras.

Additionally, you can view detailed status reports for individual recorders, ensuring optimal performance.

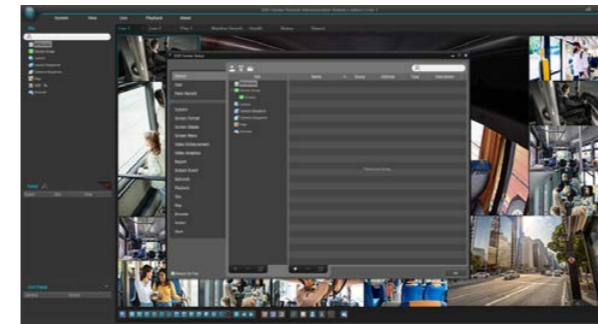

Multi-Recorder Video Playback

Easily play back video from two or more recorders on one screen. Use search filters like Event Search, Time-Lapse Search, and Thumbnail Search to quickly find the footage you need.

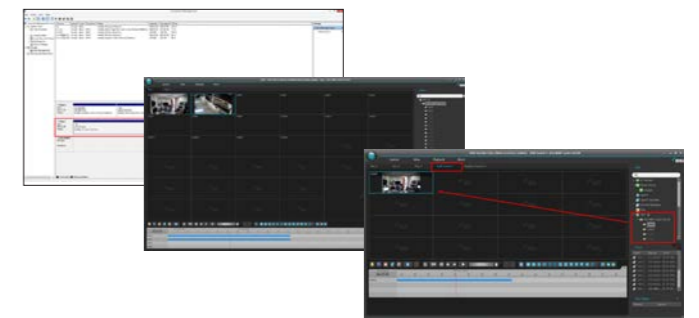

Access Your Recorder's HDD

Connect the HDD removed from the recorder to your PC. You can then register the HDD at the bottom of the left tree in the IDIS Center or run IDIS Center for iHDP to directly access and play the videos.



Map Monitoring

Displays vehicle path, current position, speed and status information in an easy-to-understand map/graph. A simple click on the vehicle icon enables viewing of recorded video.

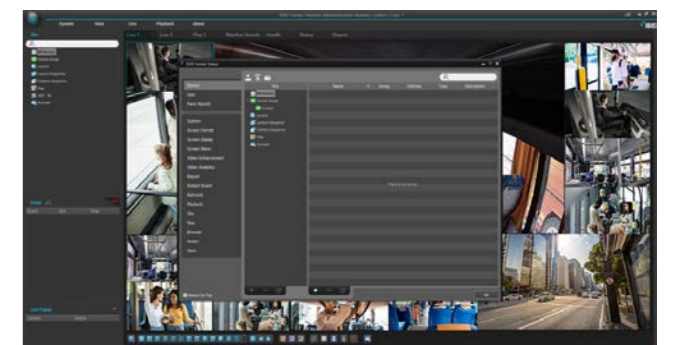

Multiple System SW Upgrade & Setup

Simultaneous software upgrade and remote setup of multiple systems.

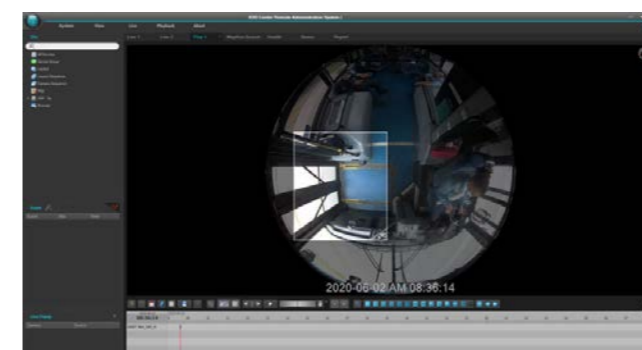

Maximizing User Convenience

Unparalleled accuracy and ease of use with "Quick Dewarping" and "Quick Playback" without switching the mode of a specific function.

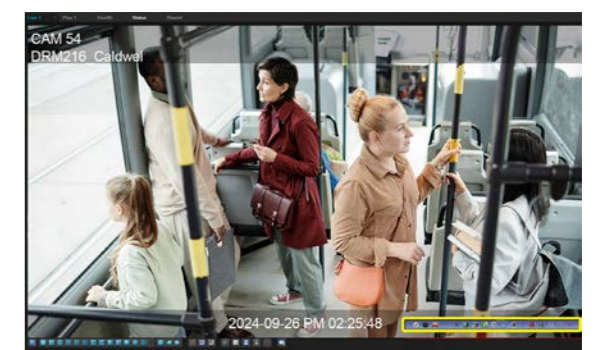

Convenient Features at a Glance

The instant playback icon lets you quickly access functions with one press. Essential tools include GPS maps, speed graphs, and vehicle information.



I-Mobile Network Solution

This setup allows you to have both live and archived video access from multiple locations (the bus and the office) with the flexibility of using internet connectivity to bridge the locations.

Building Access

- **Router on Bus:** Connects to the building's access point (Wi-Fi connection)
- **Computer in Office:** Connects to the building access point to:
 - **Retrieve Video:** Access stored video footage from the NVR on the bus

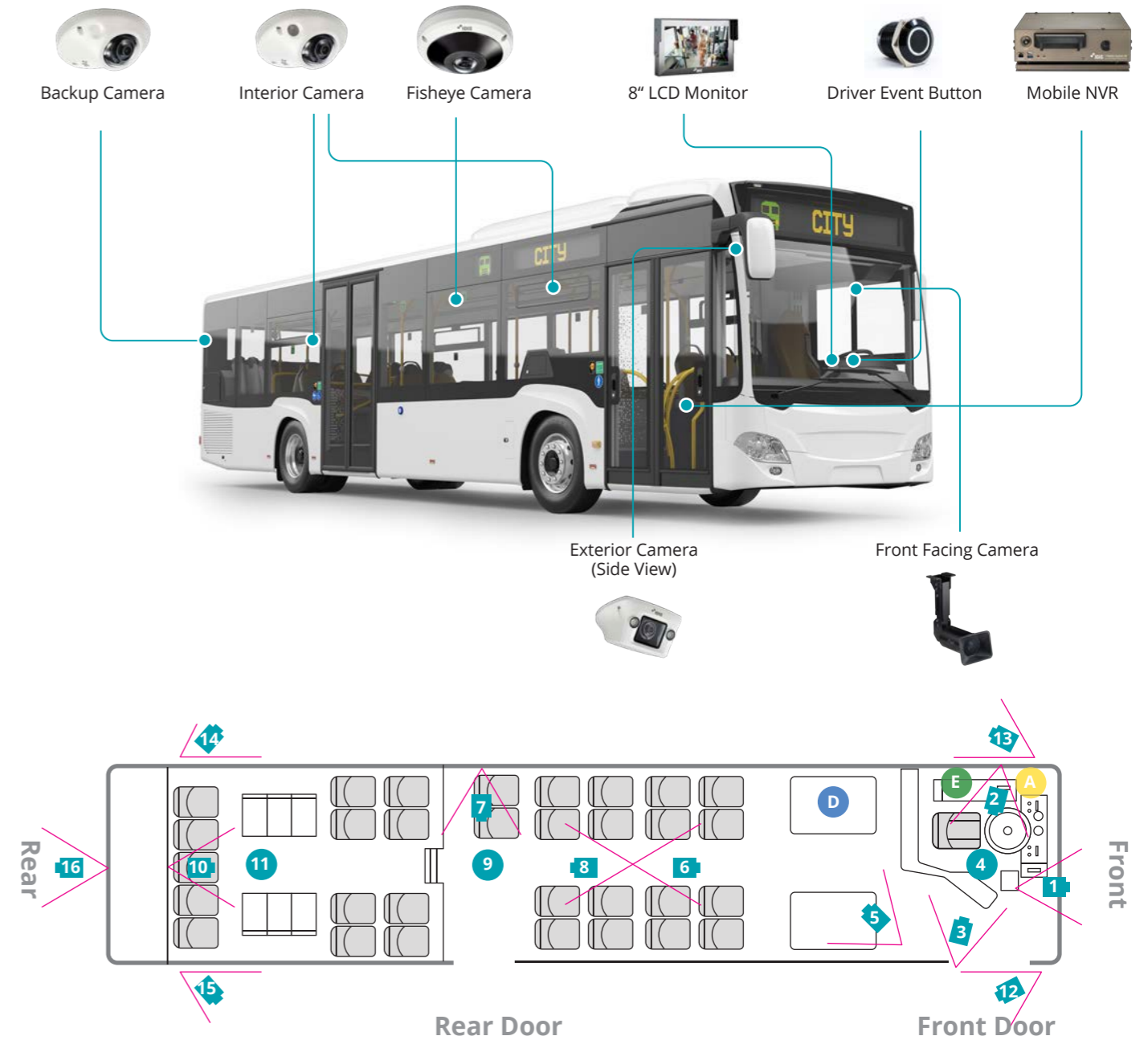
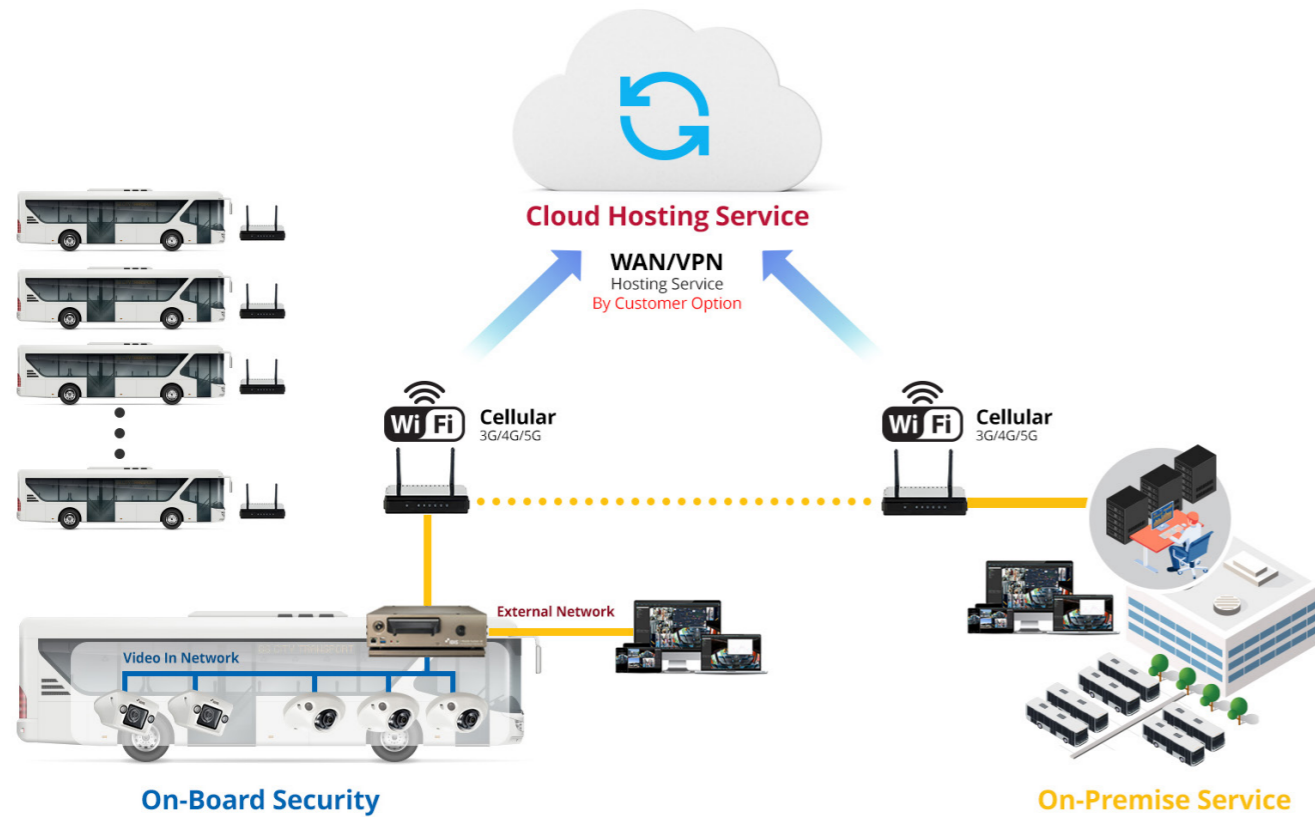

On-Bus System

- **Cameras:** Record video footage
- **NVR (Network Video Recorder):** Stores the recorded video on the bus
- **Laptop Access:** You can retrieve video footage from the NVR using a laptop connected to the NVR on the bus

Office Access

- **Server with Internet Access:** Connects to the bus's router via the internet.
- This setup allows you to:**
- **View Cameras Live:** Stream live video footage from the cameras on the bus
 - **Retrieve Stored Video:** Access previously recorded footage from the NVR on the bus

| No. | Model Name | Type |
|-----|-------------------|-----------------|
| 1 | DC-M4811X | 4K Front Facing |
| 2 | DC-M4211WRX 2.8mm | 2MP Dome |
| 3 | DC-M4211WRX 2.8mm | 2MP Dome |
| 4 | DC-Y6C17WRX | 4K Fisheye |
| 5 | DC-M4211WRX 3.3mm | 2MP Dome |
| 6 | DC-M4211WRX 3.3mm | 2MP Dome |
| 7 | DC-M4211WRX 2.8mm | 2MP Dome |
| 8 | DC-M4211WRX 3.3mm | 2MP Dome |

| No. | Model Name | Type |
|-----|-------------------|------------|
| 9 | DC-Y6C17WRX | 4K Fisheye |
| 10 | DC-M4211WRX 3.3mm | 2MP Dome |
| 11 | DC-Y6C17WRX | 4K Fisheye |
| 12 | DC-M4211HRX 3.3mm | 2MP Wedge |
| 13 | DC-M4211HRX 3.3mm | 2MP Wedge |
| 14 | DC-M4211HRX 3.3mm | 2MP Wedge |
| 15 | DC-M4211HRX 3.3mm | 2MP Wedge |
| 16 | DC-M4211WX 2.3mm | 2MP Backup |



I-Mobile Solution Products



I-Mobile System 4K Shock and vibration Resistant 16Ch Recorder

DR-M216P



- Record up to 16 high definition cameras
- Durable anti-shock and anti-vibration design
- High recording bandwidth of 90Mbps/180Mbps
- Alarm In, Motion Detection, Trip-zone, Tampering, Video Loss, Text-in, Recording Fail, Network Alarm
- Built-in acceleration sensor
- NDA / TAA Compliance



Full HD IR Mobile Dome Camera
Vandal, Shock and Vibration Resistant

DC-M4211WRX - 2.8mm / 3.3mm



- Anti-vibration On-Board Camera
- Full HD (1080p) Resolution
- Fixed-focal Lens (f=2.8mm, f=3.3mm)
- micro SD / SDHC / SDXC
- Smart Failover (Up to 256GB)
- Internal Mic
- IK10 / IP67 Supports
- PoE (IEEE 802.3af Class 3)
- Day and Night (ICR)
- True Wide Dynamic Range (WDR)
- IR LED (10 m)
- 3-axis Mechanical Design for Installation
- MIL-STD-810G supports
- NDA / TAA Compliance
- Supports ONVIF



12MP IR Mobile Fisheye Camera
Vandal, Shock and Vibration Resistant

DC-Y6C17WRX



- Easy installation with DirectIP NVR
- Supporting Edge-side Dewarping
- 12MP Sensor / 8.6MP (2944 x 2944) resolution
- Fixed-focal lens (f=1.6mm)
- micro SD / SDHC / SDXC, Smart Failover (Up to 512GB)
- IK10 / IP67 supports
- PoE (IEEE 802.3af Class 3)
- Day and night (ICR), True wide dynamic range (WDR)
- IR LED (15m / 49.2ft (4ea))
- Various viewing composition, 6 dewarping view modes
- MIL-STD-810G supports
- Supports ONVIF
- NDA / TAA Compliance



Full HD Mobile Dome Camera
Vandal, Shock and Vibration Resistant

DC-M4211WX - 2.3mm



- Anti-vibration On-Board Camera
- Full HD (1080p) Resolution
- Fixed-focal Lens (f=2.8mm)
- micro SD / SDHC / SDXC
- Smart Failover (Up to 256GB)
- IK10 / IP67 Supports
- PoE (IEEE 802.3af Class 3)
- Day and Night (ICR)
- True Wide Dynamic Range (WDR)
- 3-axis Mechanical Design for Installation
- MIL-STD-810G supports
- NDA / TAA Compliance
- Supports ONVIF



Full HD IR Mobile Wedge Camera
Vandal, Shock and Vibration Resistant

DC-M4211HRX - 3.3mm



- Anti-vibration On-Board Camera
- Full HD (1080p) Resolution
- Fixed-focal Lens (f=3.3mm)
- micro SD / SDHC / SDXC,
- Smart Failover (Up to 256GB)
- IK10 (Polycarbonate) / IK08 (Tempered Glass) Supports
- IP69K Supports
- Built-in Heater
- PoE (IEEE 802.3af Class 3)
- Day and Night (ICR)
- True Wide Dynamic Range (WDR)
- IR LED (20m)
- 3-axis Mechanical Design for Installation
- MIL-STD-810G supports
- NDA / TAA Compliance
- Supports ONVIF



H.265 8MP Mobile Front-facing Camera w/ Long Bracket

DC-M4811X - 3.07mm / 3.2mm

- 8MP (3840 x 2160) resolution
- Fixed-focal lens (f=3.07mm/3.2mm)
- PoE (IEEE 802.3af Class 3)
- Day and night (ICR)
- True wide dynamic range (WDR)
- 3-axis mechanical design for installation
- Extendable Bracket
- MIL-STD-810H Support
- Supports ONVIF
- NDAA / TAA Compliance



H.265 8MP Mobile Camera Front-facing Camera w/ Short Bracket

DC-M4811X - 3.07mm / 3.2mm

- 8MP (3840 x 2160) resolution
- Fixed-focal lens (f=3.07mm/3.2mm)
- PoE (IEEE 802.3af Class 3)
- Day and night (ICR)
- True wide dynamic range (WDR)
- 3-axis mechanical design for installation
- Compact Bracket
- MIL-STD-810H Support
- Supports ONVIF
- NDAA / TAA Compliance



Full HD Modular Covert Camera

DC-V4212XJ - 4.3mm

- Easy installation with DirectIP NVR
- Full HD (1080p) resolution
- Fixed-focal lens (f=4.3mm)
- micro SD / SDHC / SDXC
- Smart Failover (Up to 512GB)
- Two-way audio
- Alarm in / out
- PoE (IEEE 802.3af Class 4)
- True wide dynamic range (WDR)
- NDAA / TAA Compliance
- Supports ONVIF



Uninterruptible Power Supply-Battery

DP-MU2100

- Anti-vibration Uninterruptible Power Supply
- Tailored Design to Transit Industry
- Supports 15 min Back-up for Full 16ch Camera System
- 7S1P Lithium-ion Battery Pack included
- Supports Troubleshooting via Serial Communication Port
- Supports Intelligent Battery Protection w/ BMS
- 4 LED Indicators
- MIL-STD-810G Support



DirectIP 16-channel Decoder

DP-DD1316

- Supports IDIS IP Camera
- Supports HDMI, VGA, CVBS port
- Up to 480ips live display
- NDAA / TAA Compliance



DirectIP 8Ch HD Encoder

DP-DE2108

- Supports PTZ Control with UTC Protocol
- Supports 4 Audio input ports
- Supports Quadruple stream
- Supports Analog (CVBS), TVI, and AHD formats
- NDAA / TAA Compliance





Anti-vandal Driver Event Button

Driver Event Button

- IP65 Supports
- Ensures long life and durability by protecting against environmental elements
- Requires a 16mm diameter panel cutout, fitting various panel types and thicknesses
- Integrated red and green LEDs for clear visual feedback on status and conditions
- Single Pole Single Throw (SPST) with Off-(On) operation for reliable control
- 12-inch harness for easy connection and installation
- Black anodized, offering a corrosion-resistant and sleek appearance



High Performance, 25' Directional Microphone

External Microphone

- Omni 25' pick up area
- Adjustable audio gain control
- Cables for 40' or 60' buses
- Color options White or Black
- Small Compact Size
- Cables fitted with MicroMolex



GNSS Ceramic Active Antenna

GPS Antenna

- Magnetic Mount
- Ground Plane Independent
- Certificates: IP67, IP69K
- 1575-1606 MHz



Premium wide In-vehicle LCD Monitor- 8 inch

LCD Monitor- 8 inch

- Provides clear image quality with an 8-inch display
- Connects to various devices
- Improves image quality with a 3D comb filter
- Easy to use with automatic functions
- Supports multiple languages for global use
- Durable design for long-lasting performance
- NDAA / TAA Compliance



Premium wide In-vehicle LCD Monitor- 10 inch

LCD Monitor- 10 inch

- BNC, RTSP, VGA, Audio
- 3D comb filter, noise reduction
- Auto power recovery, multi-language support, trigger sensor
- 75 x 75mm VESA mount support
- 30,000 hours lifetime
- RJ-45 (2CH input)
- NDAA / TAA Compliance



Premium wide In-vehicle LCD Monitor - 19 inch

LCD Monitor - 19 inch

- BNC, HDMI, VGA, Audio
- 3D comb filter, noise reduction
- Auto power recovery, multi-language support, optional trigger sensor
- 100 x 100mm VESA mount support
- 40,000 hours lifetime
- Response Time (Less than 14ms)
- NDAA / TAA Compliance



Your ONLY Transit Safety Solution

I-Mobile Solutions



Sales

TF +1 (888) 694 7827
T +1 (469) 635 6800
E sales@idisamericas.com

Technical Support

TF +1 (888) 694 7827
T +1 (469) 635 6800
E support@idisamericas.com

IDIS HQ

IDIS Tower, 344 Pangyo-ro
 Bundang-gu, Seongnam-si
 Gyeonggi-do, 13493
 Republic of Korea

T +82 (0)31 723 5400
F +82 (0)31 723 5100
E sales@idisglobal.com

IDIS Americas

101 Wrangler Drive
 Ste.201
 Coppell, TX 75019
 U.S.A.

T +1 469 635 6800
E sales@idisamericas.com

IDIS and identifying product names and numbers herein are registered trademarks of IDIS Co., Ltd. All non-IDIS brands and product names are trademarks or registered trademarks of their respective companies. Product appearance, build status, and/or specifications are subject to change without notice. Copyright © IDIS Co., Ltd. All rights reserved.

* Product specifications in this brochure can change. Please confirm details on our website.
 * The images in this brochure are for illustrative purposes only.

For more information, please visit www.idisamericas.com



Assembly in United States